

LC Series
power amplifiers

OWNER'S MANUAL

CONTENTS

INTRODUCTION	page 1
PANEL FEATURES	page 2
SPECIFICATIONS	page 3
OPERATION	page 4
COOLING	page 6
PROTECTION	page 7
SERVICING	page 8
OPTIONS	page 9
BLOCK DIAGRAM	page 10

HILL AUDIO

A DIVISION OF ATAPCO SECURITY AND COMMUNICATIONS LTD

Tel: (0622) 741970

Fax: (0622) 741971

INTRODUCTION

Thank you for choosing a Hill Audio LC series power amplifier. This range of amplifiers represents the results of almost 20 years experience in the design and manufacture of amplifiers. Hill Audio have an extensive worldwide distributor network which allows our products to be sold and serviced in most major markets. In the event of the amplifier needing attention in a country other than that of purchase, please contact Hill Audio for the address of the nearest service agent. The LC range incorporates both tried and tested circuitry and new innovation, to produce both excellent sound quality and a high level of reliability. Hill Audio welcomes suggestions from users as to improvements and modifications to its products.

Due to our policy of continuous development, we reserve the right to alter any specification without notice.

RACK MOUNTING YOUR AMPLIFIER

It is recommended by Hill Audio that you support the back of the amplifier when mounting in a rack. Hill Audio will not be responsible for any damage (electronic or structural) caused from insufficient structural support when mounted.

WARNING

To prevent shock or fire hazard **DO NOT EXPOSE** to rain or moisture.

CAUTION

There are no user servicable parts inside the amplifier.
Any and all controls needed for operation of the amplifier are accessible from outside the amplifier.

BACK PANEL

- POWER:** IEC 3-pin socket (captive mains lead on LC1600)
- INPUT:** 1 x XLR, electronically balanced, per channel
(transformer balancing optional)
pin 2 +, 3 -, 1 ground
- 2 x 1/4" jack, electronically balanced, per channel
(transformer balancing optional)
tip +, ring -, sleeve ground
unbalanced
tip +, sleeve ground
- Screw terminals for installations
- OUTPUT:** 2 x Binding posts with integral banana sockets per channel
- ACCESSORY SOCKET:** 2 x optional 8-pin octal sockets allow the connection of
balancing transformers or other accessories.
- FANS:** 2 x 2-Speed 3" fans
- EXTERNAL CONTROL:** 3 x Screw terminals for external control of muting
(VCA controlled remote attenuation optional)
- GROUND:** Ground isolation switch
-

FRONT PANEL

- INPUT LEVEL:** Detented sensitivity control per channel
Green LED indicating signal present per channel
Red LED indicating onset of clip per channel
- ON/OFF:** Power on circuit breaker (switch in LC400 and 800)
2 x Green LED indicating power on
- PROTECTION:** 2 x Red LED indicating electronic protection circuit on
2 x Red LED indicating thermal protection circuit on
- BRIDGE:** Resessed mono bridging push switch
2 x Yellow LED indicating mono bridge active

SPECIFICATIONS

	LC400	LC800	LC1200	LC1600
Output Power (W RMS 20Hz - 20KHz)				
8Ω per channel	120	250	350	500
4Ω per channel	200	400	600	800
8Ω bridged mono	400	800	1200	1600
Pulse Power (1KHz, 10ms/100ms, single channel)				
8Ω	240	500	700	1000
4Ω	400	800	1200	1600
Distortion (DIN - at rated power at 8Ω)				
THD+N (1KHz)			<0.01%	
THD+N (20Hz - 20KHz)			<0.03%	
IMD			<0.01% (60Hz/7KHz 4:1)	
Crosstalk (Referred to full power at 8Ω)				
1KHz			<-80dB	
20Hz - 20KHz			<-60dB	
Noise (Referred to full power at 8Ω)				
			<-100dB (20Hz - 20KHz)	
Slew Rate				
			>40V/μsec	
Rise Time				
			3μsec	
Damping Factor (100Hz)				
			>300	
Frequency Response (20Hz - 20KHz)				
			+0/-0.5dB	
Sensitivity				
			1.0V RMS for rated output	
Input Impedance				
			10K unbalanced, 20K balanced Independent of input attenuator	
Size				
			19" rack mount 3.5" high (2 rack spaces) 14.25" behind back panel	
Weight				
Kgs	8	14	16	19
Lbs	17	30	35	41
N^o of Fans				
	1	2	2	2
N^o of power transistors (total)				
	8	12	20	20
Fuse Requirements				
100/120V AC 60Hz	T6.3A	T12A	T16A	T20A
220/240V AC 50Hz	T3.15A	T6.3A	T8A	T10A

The supply voltage is NOT switchable, so verify the voltage of your amplifier BEFORE switching it on.

OPERATION

CIRCUITRY - TOTAL SYMMETRY

Using a unique transformer coupled driver stage, the LC range feature identical ultra-linear NPN output devices connected in a 'Super A' sliding bias configuration exhibiting a much more linear response than conventional amplifiers using NPN and PNP devices. The negative feedback is a very low 26dB and, in addition, the transformer coupled drive interrupts the DC voltage chain - eliminating all the circumstances in which a conventional amplifier can introduce DC voltage onto the speaker.

INPUT SENSITIVITY - 1.0V RMS

This multi-position control is graduated from 0dB to - infinity. Your LC amplifier will develop rated output power as long as the signal input is at least 1.0 volts RMS.

CONNECTING AN INPUT SIGNAL

The LC amplifiers will accept balanced and/or unbalanced signals using 3 pin XLRs, stereo 1/4" jacks and mono 1/4" jacks. The connector not being used for signal input can be used to link input channels of different amplifiers to the same signal - e.g. with signal into the LEFT channel using an XLR connector, one of the 1/4" jacks can be used to feed signal to the right channel input of the same amplifier, or one or both inputs of any other LC amplifier by using a 1/4" jack to 1/4" jack lead (stereo or mono), or a 1/4" jack to 3-pin XLR lead (balanced or unbalanced).

Screw terminals are provided on the rear panel to allow users to permanently wire the amplifier into an installation. All of the inputs are available on this block.

BRIDGE

When the mono bridging switch is depressed, the amplifier is in the BRIDGE mode: both channels are now internally connected, so only the left channel signal input is needed to drive the amplifier.

The output connections should be between the RED terminals of the output sockets.

AC SWITCH

The AC circuit breaker (switch in LC400 and 800) is ON in the down position

GROUND LIFT

Some ground-loop hum problems may require isolating the audio (technical) ground from the AC ground: moving the switch provided achieves this.

N.B.-the AC ground remains permanently connected to chassis.

REMOTE MUTING

Due to logic control of the protection and muting circuits, LC amplifiers are capable of being remotely muted. Each side of the amplifiers can be independently muted. This is accomplished by connecting the screw terminals marked external control to either one or two switches. When 10V is applied to terminal 1, channel 1 is muted, likewise when 10V is applied to terminal 2, channel 2 is muted. Control switches may either be self-built, for example in a console with a number of switches to centrally control the status of many amplifiers. Simple switches may also be purchased from any of the Hill Audio distributors.

COOLING

FANS:

Two speed fans are fitted to LC series amplifiers. These fans run continuously at low speed, switching to higher speed when the heatsink temperature reaches 60°C.

It is recommended that the fan covers are cleaned of dust periodically.

RUNNING TEMPERATURE:

Hill Audio amplifiers use a 'Super A sliding bias configuration' which contributes to the high level of audio fidelity obtainable with these amplifiers. This biasing enables both banks of transistors to be running when the amplitude of the input signal is close to zero, thus allowing the amplifier to respond to transients extremely quickly. This, however means that in comparison to the class A-B or B designs commonly employed in high power amplifiers, these amplifiers will run at a relatively high temperature even under idle conditions. This is normal and in fact increases the life of internal components as they are not subject to 'thermal cycling' (the term given to the continual warming up and cooling down of the amplifier with varying input signals) as is the case with class A-B and B designs.

CLEANING:

The transistors are cooled especially efficiently due to the tunnel-like construction of the transistor banks. It is important however that fan covers are cleaned periodically to prevent as build-up of dust which could adversely affect the cooling capability of the amplifier.

PROTECTION

The LC range of amplifiers has an entirely new and comprehensive 5-way electronic and thermal protection system. This is designed to protect the amplifier and ancillary equipment from any possible fault conditions. It is centrally controlled using a logic circuit and operates as follows:

1. In the event of overvoltage being received by the amplifier, it is shut off by means of the circuit breaker which forms the AC on/off switch. Further protection is afforded by a rear panel-mounted AC fuse (on LC400 and 800 there is no circuit breaker, only an on/off switch and a fuse).
2. In the event of a low output impedance being sensed by the central logic circuit caused, for example by a short-circuit in a speaker lead, the input to the front end of the amplifier is muted. The amplifier will drive into a short-circuit indefinitely with no input signal present.
3. In the unlikely event of any fault in either the mains transformer or the regulation circuit, leading to overvoltage on the amplifier DC power rails, an internal fuse will immediately blow and the speaker relay will simultaneously operate to mute the output of the amplifier as a failsafe measure. This will prevent the internal components of the amplifier being stressed by this overvoltage. The blown internal fuse will prevent operation of the amplifier until it is opened up and checked by an authorised Hill Audio service agent.
4. The speakers are muted during switch on and off of the amplifier to prevent the possibility of an damage caused by switch on or off 'thumps'.
5. The amplifiers are fully thermally protected by means of a thermistor which, via the central logic circuit, mutes the input signal when the heatsink temperature reaches 85°C. As the amplifier is now not being driven and the fans are still running at high speed the temperature of the amplifier will quickly drop and when it falls below 70°C the input signal is reconnected.

SERVICING

In the LC range of amplifiers, servicing is speeded up in 2 important ways:

A. USE OF MODULAR ELECTRONICS

Each part of the amplifier is contained on its own separate pcb, connected to the remainder of the circuitry by plug-in connectors. Thus it is easy to replace any faulty pcb quickly and easily.

B. USE OF MODULAR TRANSISTOR BANKS.

In all LC amplifiers, the power transistors are mounted directly to an aluminium heatsink extrusion. This can be removed from the amplifier by means of only 5 screws, thus facilitating quick changing of transistor banks. This process is also made easier because the biasing circuit pcb is also connected to this heatsink and is therefore also exchanged. Thus, the incoming transistor bank will already be biased to match the amplifier. Whilst for optimum performance final fine tuning of the biasing circuit should be carried out in-situ, the amplifier will perform admirably until time is available for this process to be carried out. Thus, for example, in the unlikely event of a transistor failure in an amplifier driving, say, studio monitors, the transistor bank can be replaced within a few minutes allowing the session to continue and the amplifier to deliver good results until 'down time' is available to finely tune the biasing, thus restoring the amplifier to the peak of its performance.

OPTIONS

A. VCA ATTENUATION

When the optional VCA attenuation is fitted (either before delivery or retro-fitted by an authorised Hill Audio service agent) the external control screw terminals will accept a control voltage of 0-10V to control the level of the amplifier. In this case, a voltage applied to terminal 1 controls the level of channel 1 and applied to terminal 2 controls channel 2. Terminal 0 is a ground terminal common to both channels. It is important to note that the voltage applied raises the volume from zero to the level preset at the input attenuator. Simple remote attenuators may be purchased from any of the Hill Audio distributors. These attenuators also incorporate mute buttons.

B. OCTAL SOCKETS

When the optional accessory pcb has been fitted (either before delivery or retro-fitted by an authorised Hill Audio service agent) the 2 circular knock-out panels and the back panel of the amplifier can be removed to reveal 2 8-pin octal sockets. These can be used to accommodate plug-in input balancing transformers (available from Hill Audio distributors) or other plug-in accessories, for example crossover units.

C. LIMITING *

A limiter pcb is available which, when fitted (either prior to delivery or retro-fitted by an authorised Hill Audio service agent) will limit the output of the amplifier prior to clipping. This is of use to protect speakers in applications in which the amplifier may be unwittingly driven to beyond its maximum output power, for example in installations in which the clip indicators on the front panel of the amplifiers are not easily visible.

(* This option will be available in autumn 1989 but may be retro-fitted to any LC series amplifier)

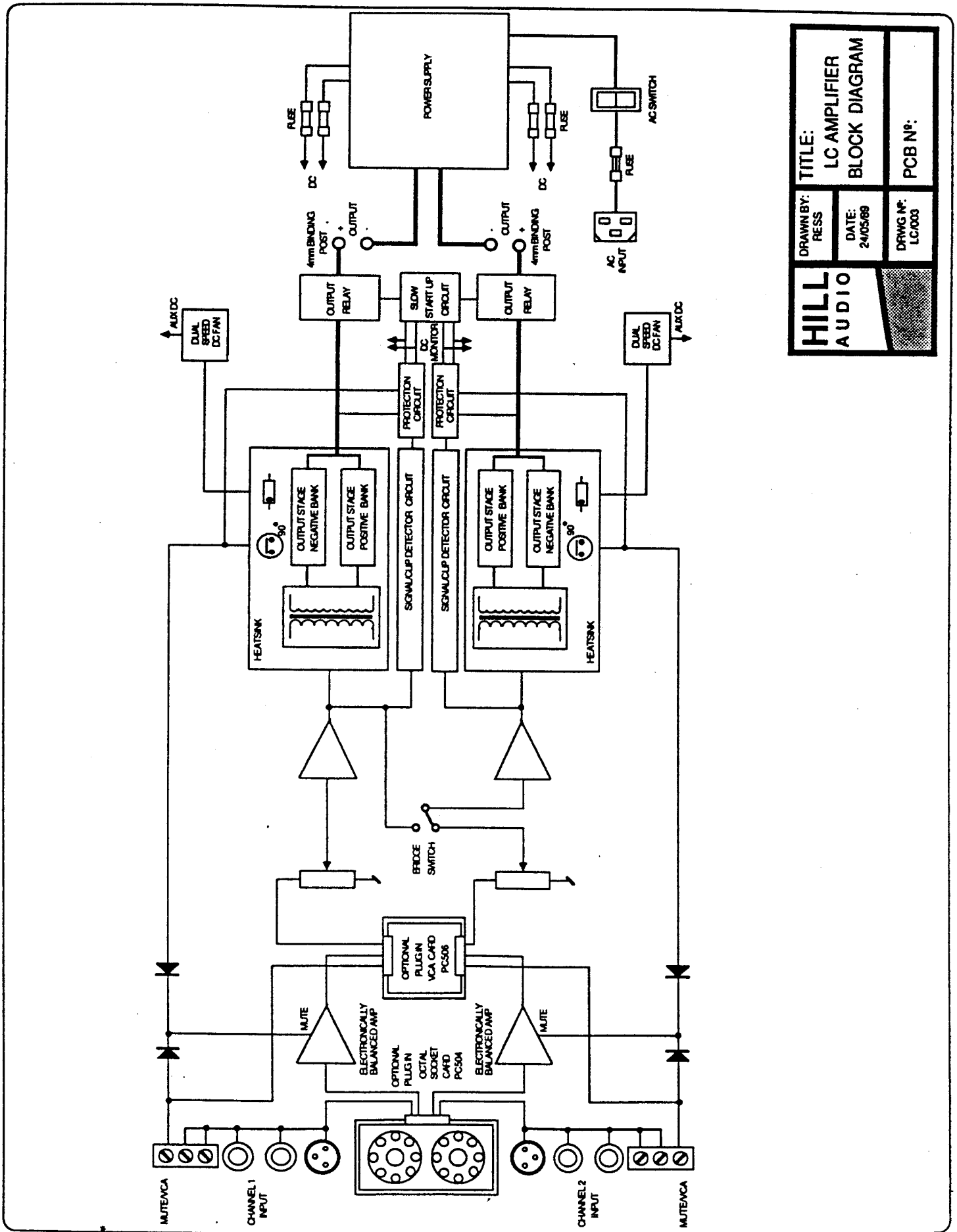

HILL AUDIO	DRWNG N°: LC/003	PCB N°:
	DATE: 24/05/88	
DRAWN BY: RESS		TITLE: LC AMPLIFIER BLOCK DIAGRAM

Front Panel

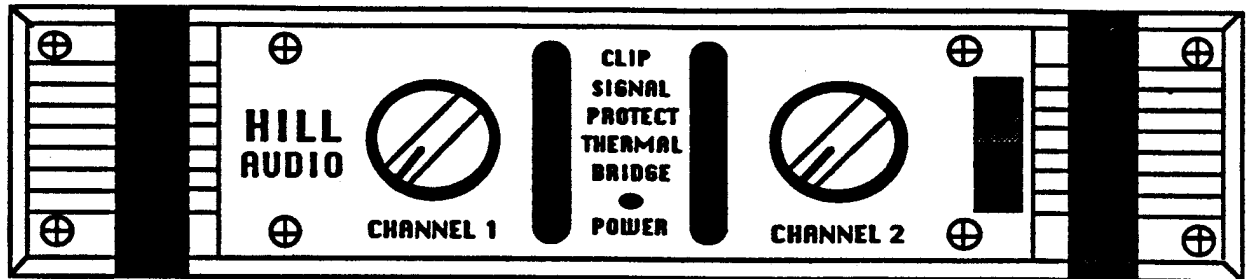

Back Panel

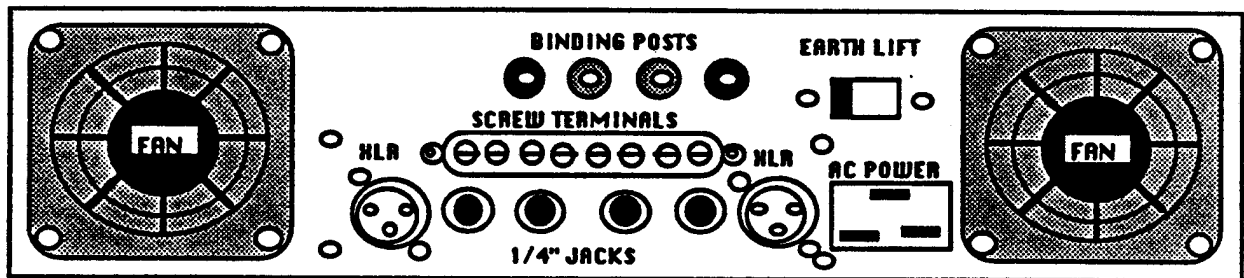

ML Front Panel

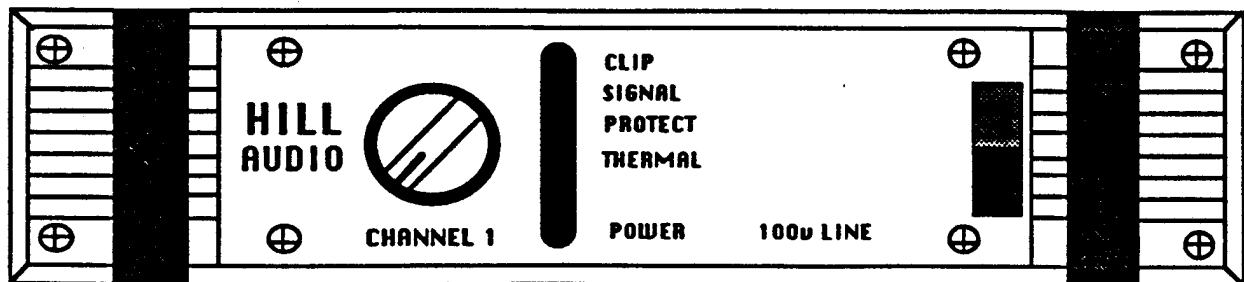

LC AMPLIFIER

CIRCUIT DIAGRAMS

LC AMPLIFIER COMPONENT LIST

PC 502

R1 15K	R41 68K	C1 47 μ f ele 25v	D1 10v ZEN	TR1 BD131
R2 33K	R42 10K	C2 22 pf	D2 10v ZEN	TR2 BD132
R3 2K2	R43 10K	C3 47 μ f ele 25v	D3 1N4148	TR3 BD131
R4 3K9	R44 51K	C4 680 pf	D4 1N4148	TR4 BD132
R5 3K9	R45 10K	C5 220 pf	D5 1N4148	TR5 BC184
R6 1K	R46 100K	C6 100 μ f ele 6.3v	D6 1N4148	TR6 BC184
R7 3K9	R47 51K	C7 10 pf	D7 1N4148	TR7 BC184
R8 22K	R48 220K	C8 10 μ f ele 100v	D8 1N4148	TR8 BC184
R9 100 Ω	R49 1K	C9 10 μ f ele 100v	D9 1N4148	TR9 BC184
R10 100 Ω	R50 220K	C10 150 pf	D10 1N4148	TR10 BC184
R11 3K3	R51 220K	C11 47 μ f ele 25v	D11 1N4148	TR11 BC184
R12 3K3	R52 2K2	C12 10 pf	D12 1N4148	TR12 BC184
R13 1 Ω 2W5	R53 2K2	C13 47 μ f ele 25v	D13 1N4148	
R14 15K	R54 560 Ω	C14 680 pf	D14 2v7 ZEN	LED1 YELLOW
R15 15K	R55 560 Ω	C15 220 pf	D15 1N4148	LED2 RED
R16 33K	R56 100K	C16 100 μ f ele 6.3v	D16 2v7 ZEN	LED3 GREEN
R17 2K2	R57 51K	C17 10 pf	D17 1N4148	LED4 RED
R18 3K9	R58 68K	C18 10 μ f ele 100v	D18 10v ZEN	LED5 GREEN
R19 3K9	R59 68K	C19 10 μ f ele 100v	D19 10v ZEN	LED6 GREEN
R20 1K	R60 10K	C20 150 pf	D20 1N4148	LED7 GREEN
R21 3K9	R61 51K	C21 2.2 μ f tnt 16v	D21 1N4148	LED8 RED
R22 22K	R62 10K	C22 0.47 μ f ply	D22 1N4148	LED9 RED
R23 100 Ω	R63 100K	C23 47 μ f ele 25v	D23 1N4148	LED10 RED
R24 100 Ω	R64 51K	C24 2.2 μ f tnt 16v	D24 1N4148	LED11 RED
R25 3K3	R65 10K	C25 0.47 μ f ply	D25 1N4148	LED12 YELLOW
R26 3K3	R66 1K5	C26 47 μ f ele 25v	D26 1N4148	
R27 1 Ω 2W5	R67 1K5		D27 1N4148	UR1 10K IIn
R28 1 Ω 2W5	R68 560 Ω		D28 1N4148	UR2 10K IIn
R29 560 Ω	R69 560 Ω		D29 1N4148	
R30 220K	R70 100K (LC1200)		D30 1N4148	
R31 1K	R70 68K (LC800)		D31 2v7 ZEN	
R32 220K	R70 27K (LC400)		D32 1N4148	
R33 220K	R71 100K (LC1200)		D33 2v7 ZEN	
R34 2K2	R71 68K (LC800)		D34 1N4148	
R35 2K2	R71 27K (LC400)		D35 1N4148	
R36 560 Ω				
R37 560 Ω			IC1 5532	
R38 100K			IC2 5532	
R39 51K			IC3 347	
R40 68K			IC4 347	

PC 503

R1 5K1	R11 5K1	C1 22 pf	D1 1N4148	TR1 BC184
R2 10K	R12 100K	C2 22 pf	D2 1N4148	TR2 -
R3 5K1	R13 20K	C3 47 μ f ele 25v	D3 1N4148	TR3 BC184
R4 100K	R14 1K	C4 47 μ f ele 25v	D4 1N4148	
R5 10K	R15 1K	C5 22 pf	D5 1N4001	
R6 20K	R16 33K	C6 22 pf	D6 1N4002	IC1 5532
R7 20K	R17 33K	C7 22 pf	D7 1N4002	IC2 4053
R8 10K	R18 20K	C8 22 pf	D8 1N4002	IC3 5532
R9 5K1	R19 51K	C9 330 pf	D9 1N4002	IC4 TDR2030
R10 10K	R20 4.7 MEG	C11 1 μ f tnt 35v	D10 1N4002	
(LC 1200)	R21 2K5	C12 1 μ f tnt 35v	D11 1N4002	F1 10A LC1200
(LC 800)	R21 2K5	C13 1 μ f tnt 35v	D12 1N4002	F2 10A LC1200
(LC 400)	R21 1K5	C14 1 μ f tnt 35v	D13 1N4002	F3 10A LC1200
		C15 100 μ f ele	D14 1N4001	F4 10A LC1200
		C16 1 μ f tnt 35v	D15 7v5 ZEN	F5 1A
		C17 6800 μ f ele 35v	D16 15v ZEN	F6 1A
		C18 6800 μ f ele 35v		
		C19 470 μ f ele 25v		
		C20 470 μ f ele 25v		
		C21 47 μ f ele 25v		

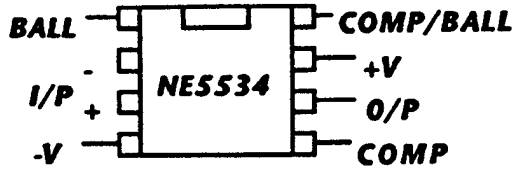
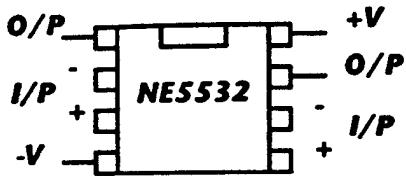

BD 131/132

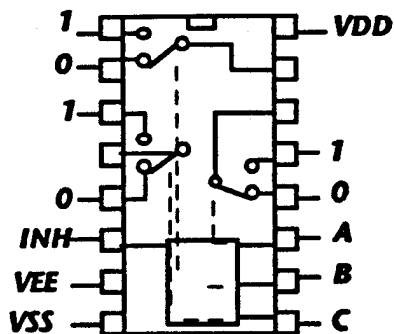
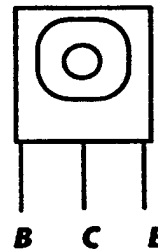

4053B

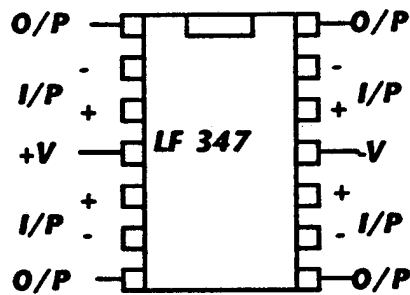

MJ15003/MJ15024

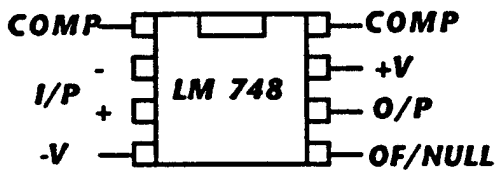
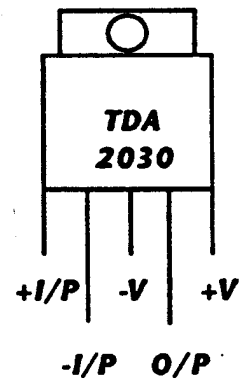
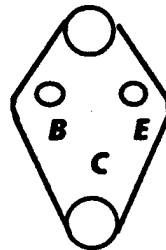

+V 7818

-V 7918

BC 184L

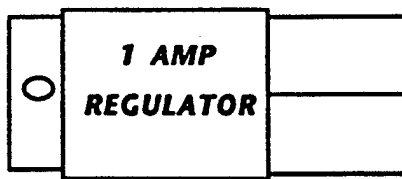

OUTPUT
EARTH
INPUT

OUTPUT
INPUT
EARTH

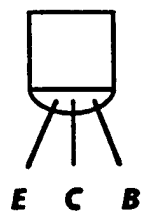

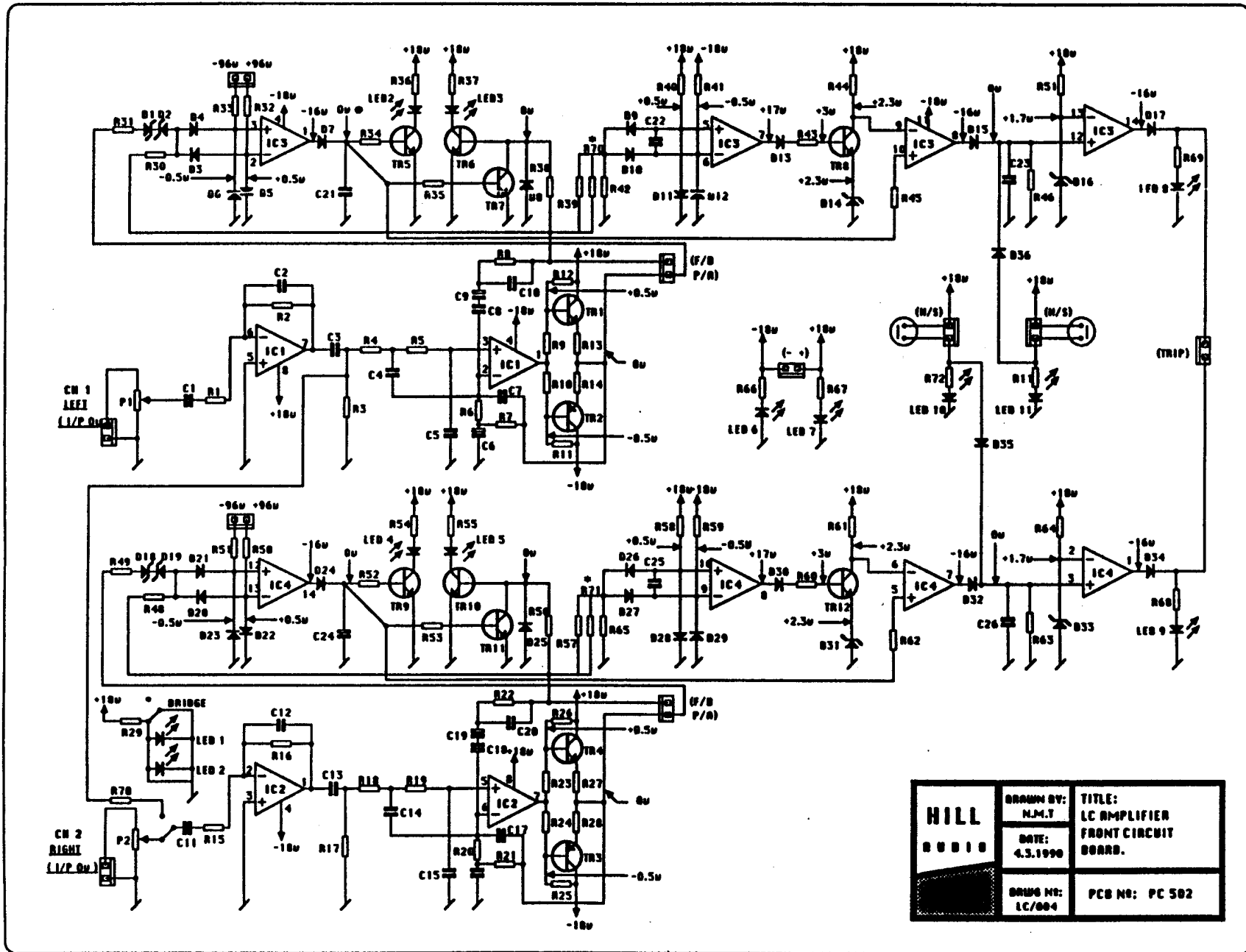

HILL AUDIO	DRAWN BY: N.M.T	TITLE: LC AMPLIFIER FRONT CIRCUIT BOARD.
	DATE: 4.3.1990	
	DRAWN NO: LC/004	PCB NO: PC 502

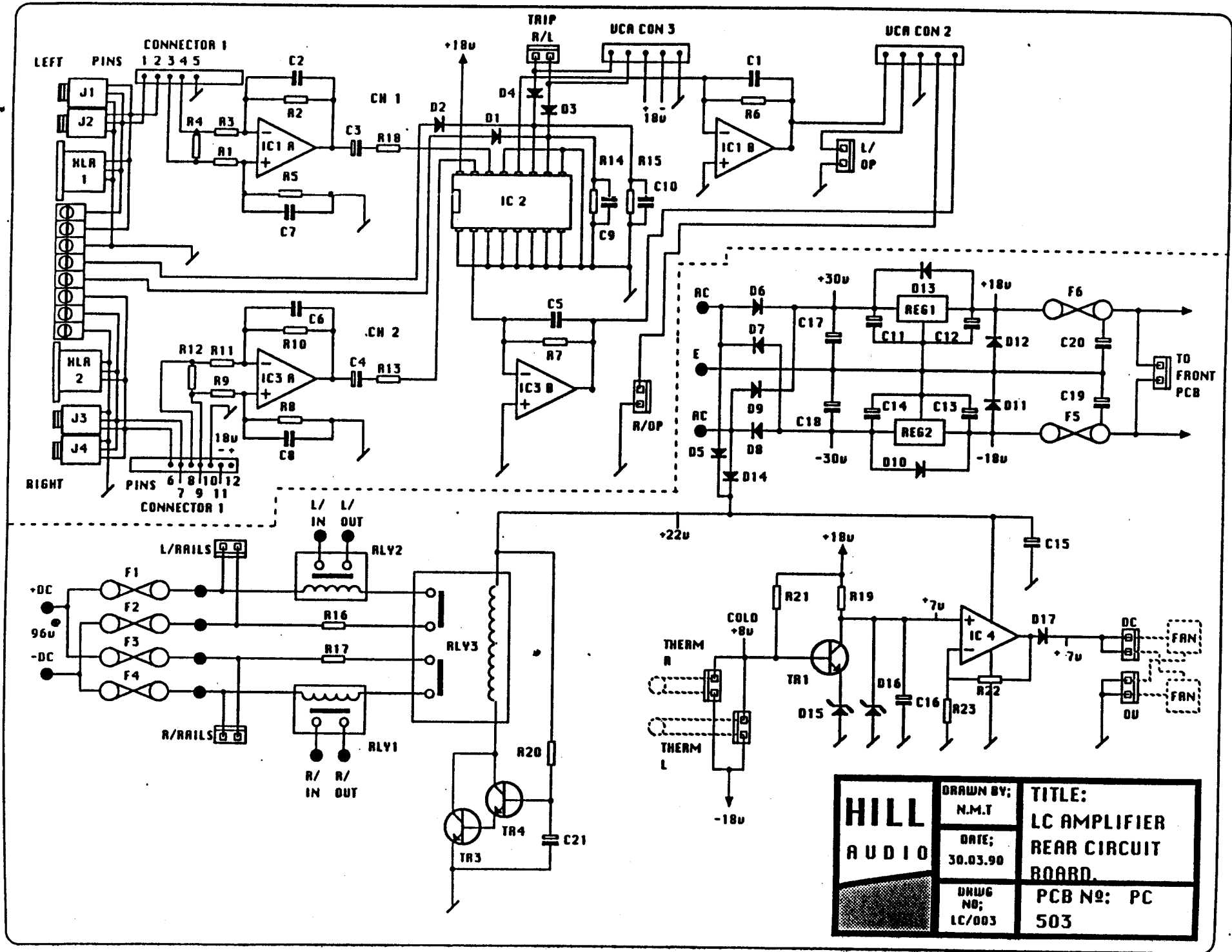

HILL AUDIO	DRAWN BY: N.M.T	TITLE: LC AMPLIFIER REAR CIRCUIT BOARD.
	DATE: 30.03.90	PCB NO: PC 503
	DRAWG NO: LC/003	